

Assembly Instruction Sheet #IS-1715P70-10

For Style 1715P70-10

Tools Required: Flathead screwdriver, Phillips screwdriver, pliers, wire cutters, wire strippers, electrical tape, safety glasses.

Light Source: 120V LED *45W DIMMABLE (3000K, 4000K, 5000K).

Preparation: Identify and inspect all parts before beginning installation. Check package content list and diagrams below to be sure all parts are present. If any parts are missing or damaged, do not attempt to assemble, install, or operate the fixture. Contact customer service for replacement parts.

⚠ Warnings and Cautions

Turn off electricity at circuit breaker or main fuse box before installation. Consult a licensed electrician if in doubt.

These instructions are provided for your safety. It is very important you read them completely before installing the fixture.

We strongly recommend that a licensed, professional electrician perform the installation.

Disconnect fixture from power source before replacing bulbs. Make sure bulbs are given sufficient time to cool before removal.

Package Contents

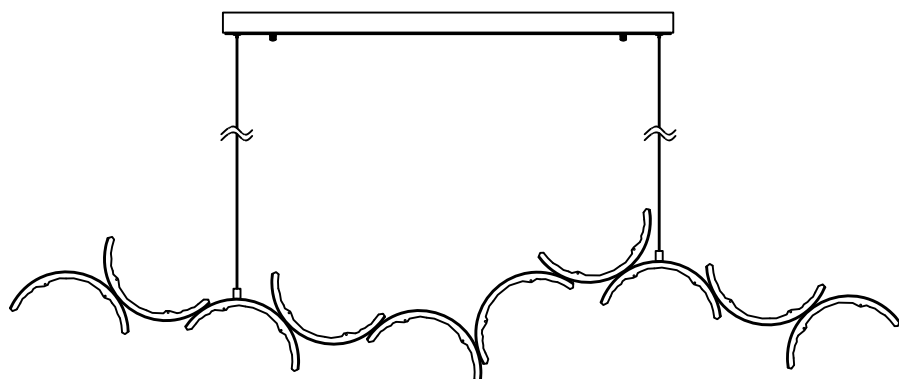

A Fixture Body x1



B glass x10

Hardware Contents

PART	DESCRIPTION	QUANTITY
BB	Wire nut	2pcs
CC	Screw	4pcs

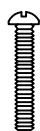

STEP 1- Place the glass into the frame, ensuring it fits securely, then tighten the screws to hold it in place.

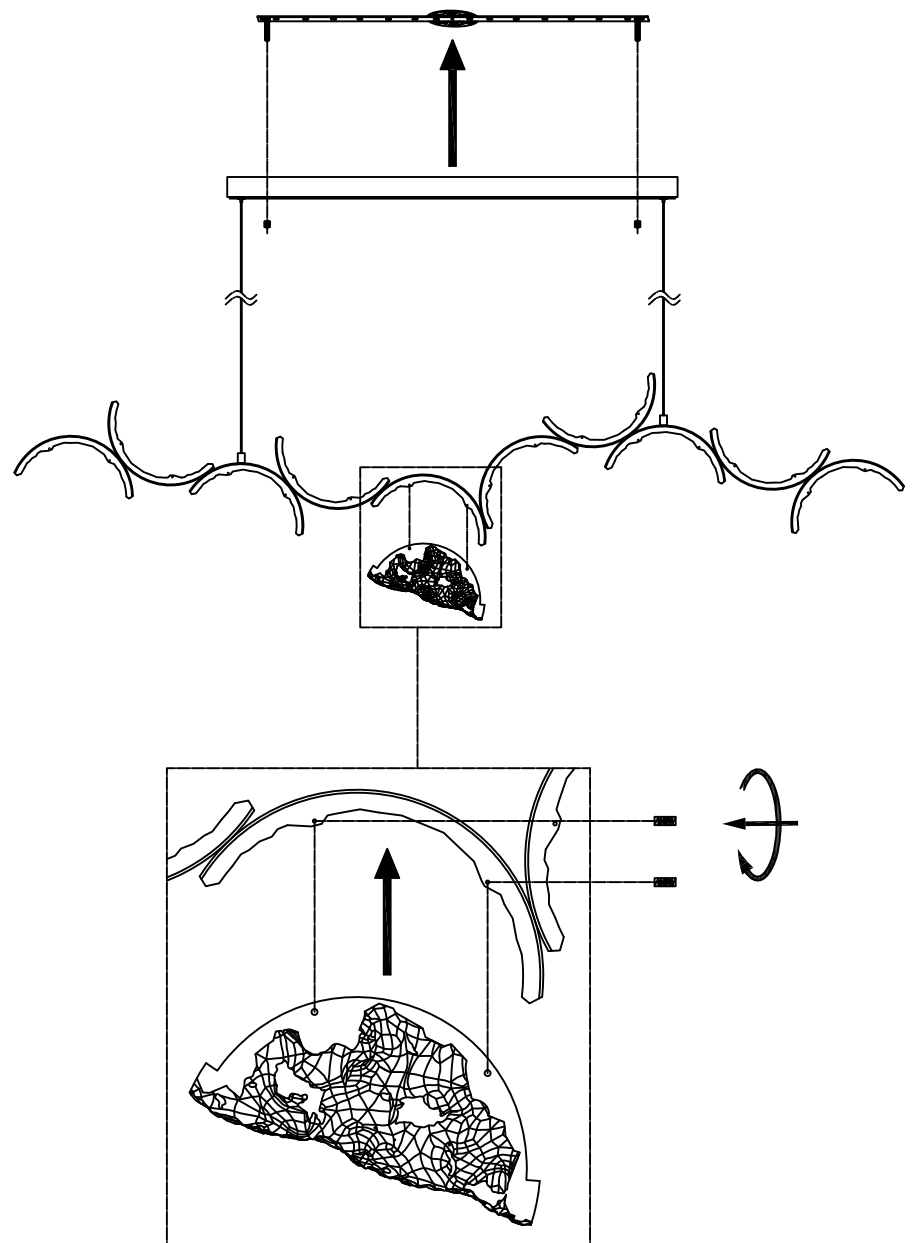

Figure 1

STEP 2 - Attach Mounting bracket to Outlet Box

A. Pass the supply wires through the Mounting bracket (EE). Attach the Mounting bracket (EE) to the Outlet Box with the head of the Green Ground Screw facing you. Secure it with Outlet Box Screws (CC). Tighten until snug.

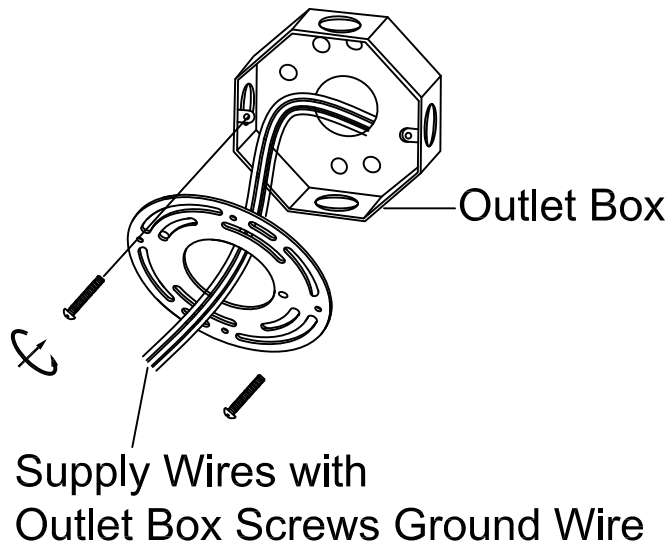

Figure 2

STEP 4 - Because the lamp body is relatively heavy, please pay attention to the bearing screws when installing the hanging plate.

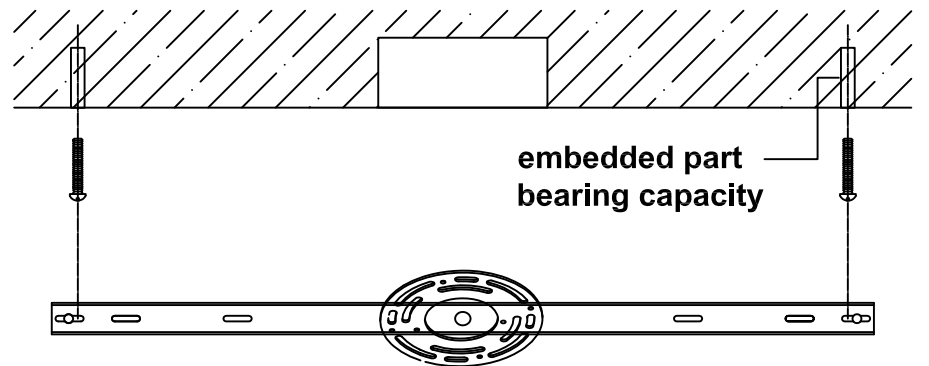

Figure 4

STEP 3 - Wire Connections

A. Use standard wire connectors to make all wire connections. Twist connectors until wires are tightly joined together. Wrap each connection with approved electrical tape and carefully stuff all the connected wires into the Outlet Box.

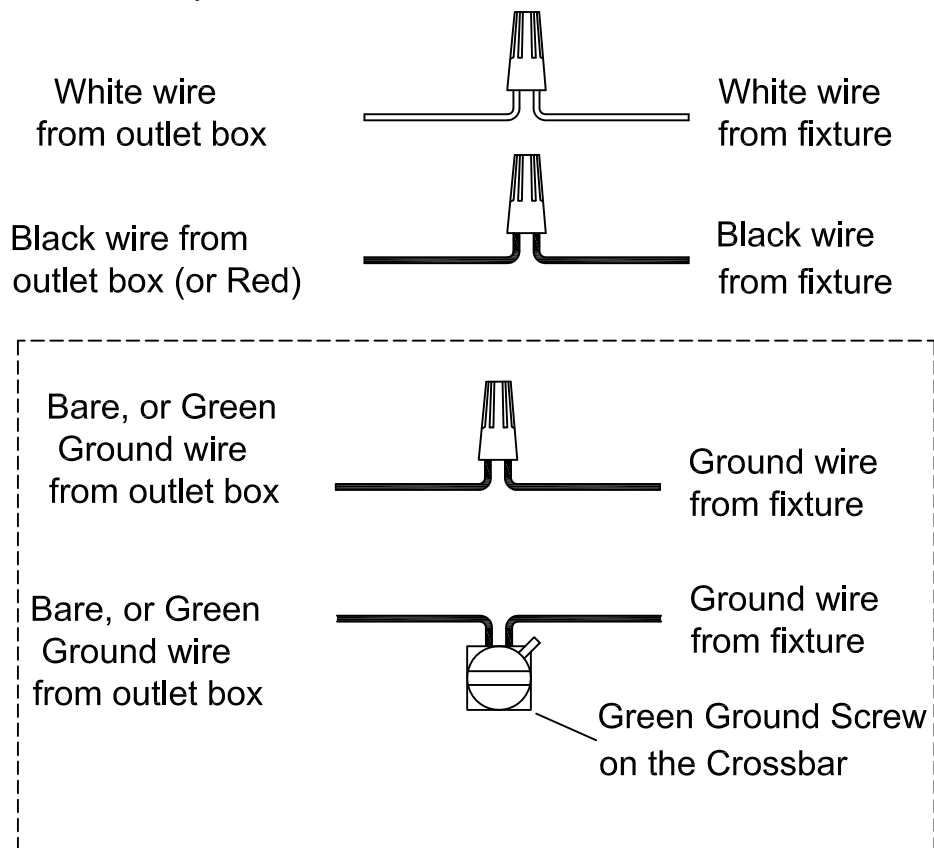

Figure 3

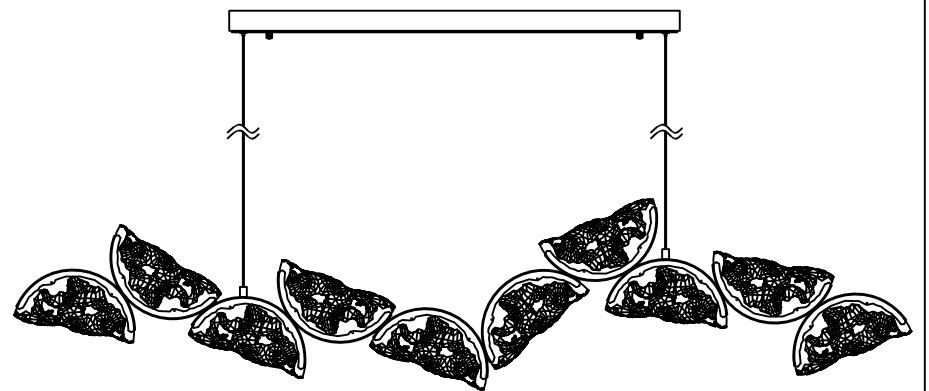

Figure 5